

節流閥 Throttle Valves



閥類型符號 SYMBOL

TV-G※



規格說明 SPECIFICATION :

型式 MODEL		最高使用壓力 MAX. OPERATING PRESSURE kgf/cm ²	流量 RATED FLOW l/min	重量 WEIGHT kg	
管式安裝 THREADED CONNECTIONS	板式安裝 SUB-PLATE MOUNTING				
TV-T03-10	TV-G03-10	250	30	1.1	1.4
TV-T06-10	TV-G06-10		80	2.8	2.4
TV-T10-10	TV-G10-10		200	6.1	5

型號說明 HOW TO ORDER :

TV-G - 03 - 10



設計編號 DESIGN NUMBER

閥規格 VALVE SIZE

03 : 3 / 8" 06 : 3 / 4" 10 : 1 - 1 / 4"

安裝型式 MOUNTING

G : 板式安裝 SUB-PLATE MOUNTING
T : 管式安裝 THREADED CONNECTIONS

系列編號 SERIES NUMBER

附屬品 ATTACHMENT :

型式 MODEL	安裝螺絲 SOC HOL CAP SCREW
TV-G03	M8 X 35L.....4pcs
TV-G06	M10 X 45L.....4pcs
TV-G10	M12 X 60L.....4pcs

Throttle Valves

單位UNIT : mm

安裝尺寸 INSTALLATION DIMENSIONS

TV-603-10

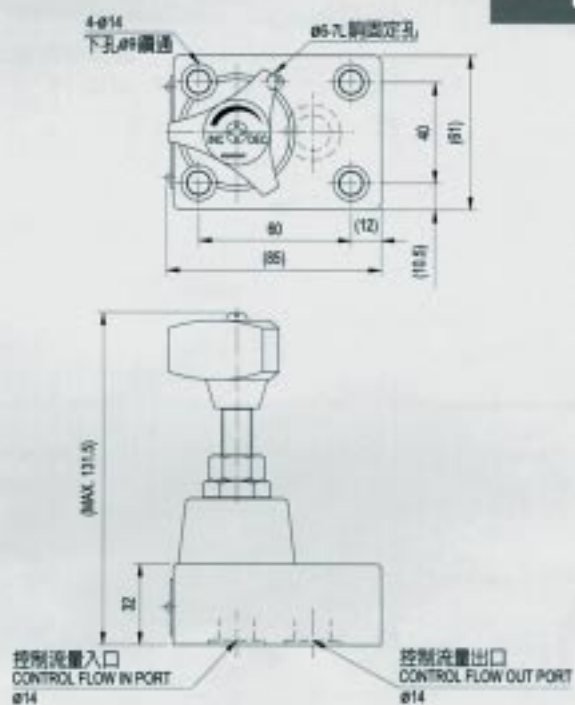

TV-606-10

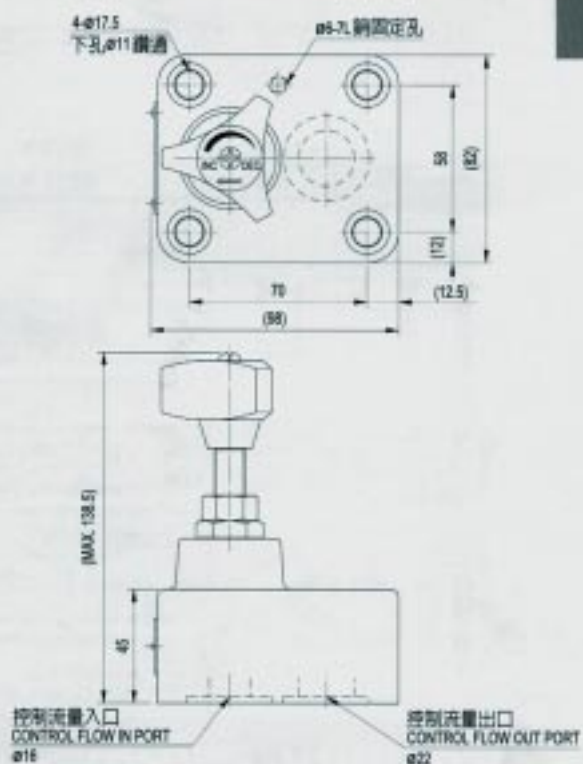

Throttle Valves

單位UNIT : mm

安裝尺寸 INSTALLATION DIMENSIONS

TV-G10-10

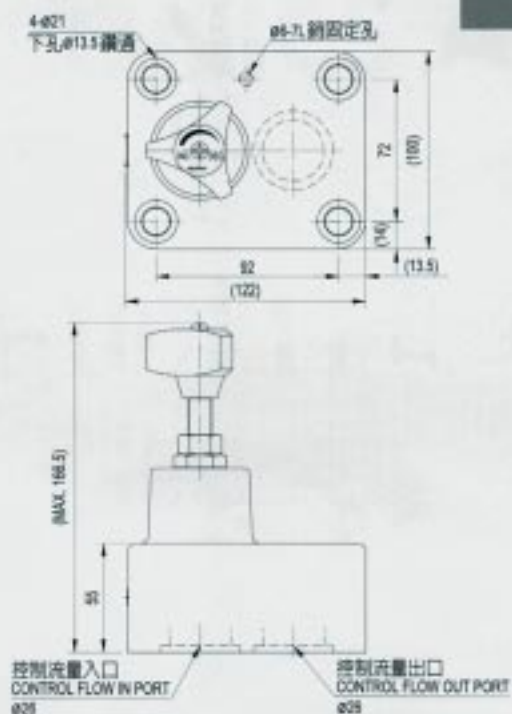

TV-T03

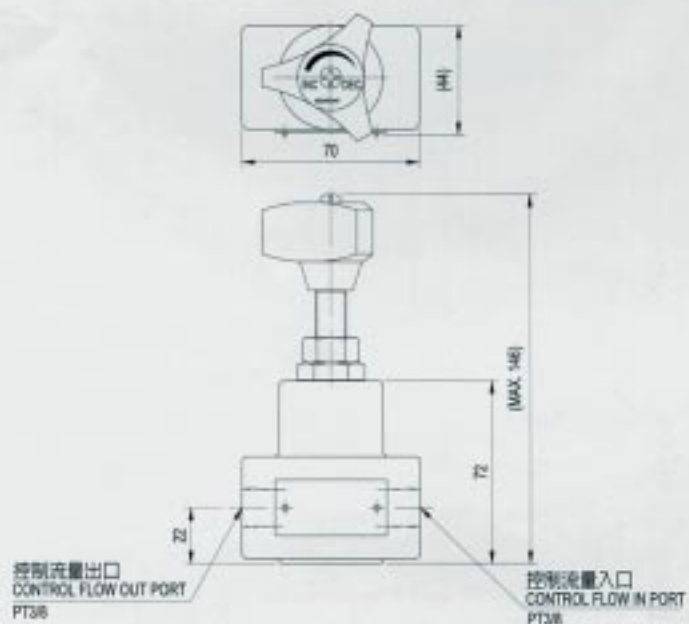

Throttle Valves

單位UNIT : mm

安裝尺寸 INSTALLATION DIMENSIONS

TV-T06

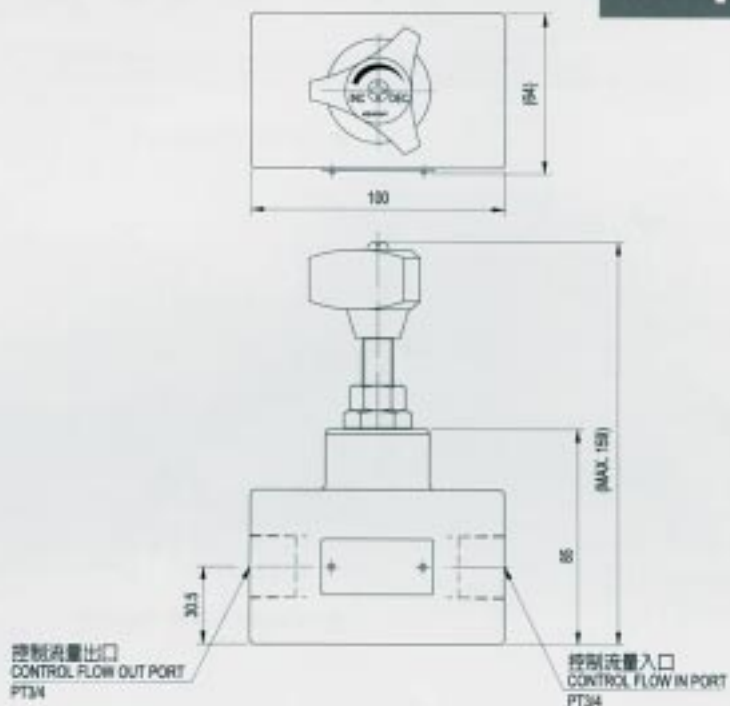

TV-T10

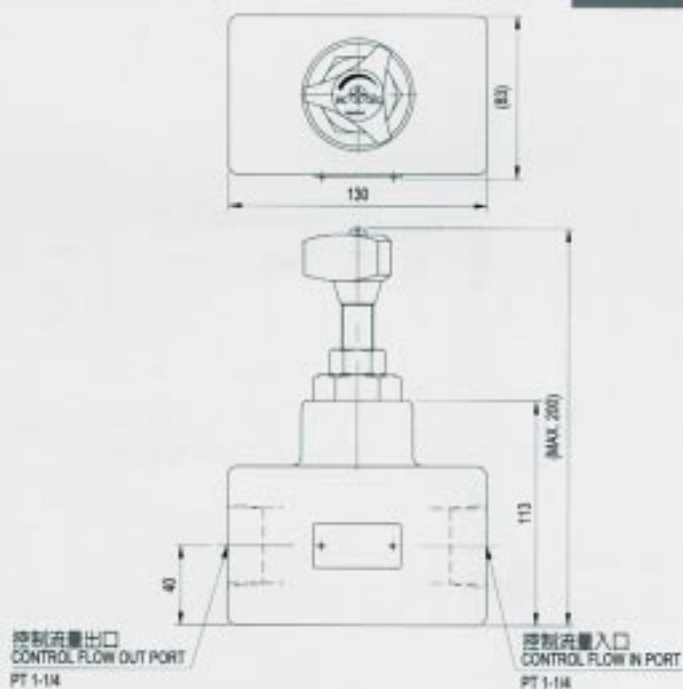

Throttle Valves

測試條件 PERFORMANCE CURVES:

測試油黏度 TEST FLUID VISCOSITY : 35 cSt

測試油溫度 TEST TEMPERATURE : 50°C

流量與調整旋鈕特性 METERED FLOW vs ADJ. REVOLUTIONS

壓力降特性 PRESSURE DROP

● TV-※03

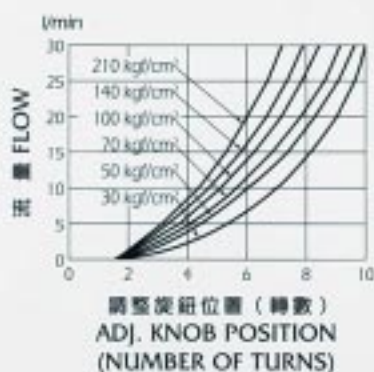

● TV-※03

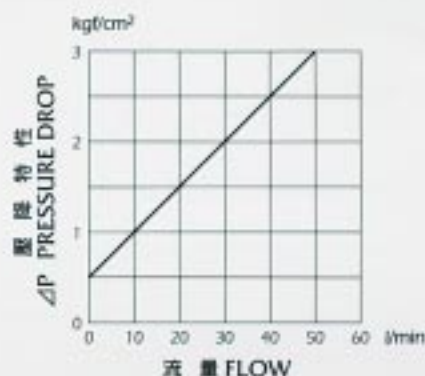

● TV-※06

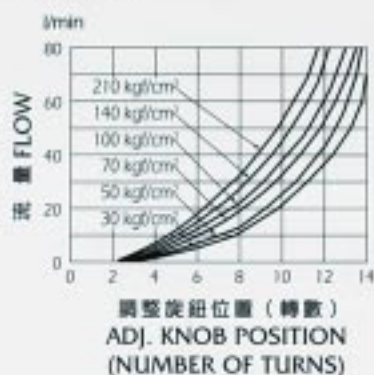

● TV-※06

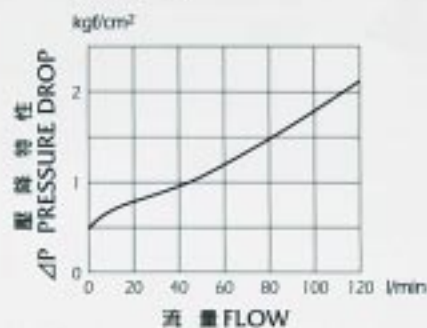

● TV-※10

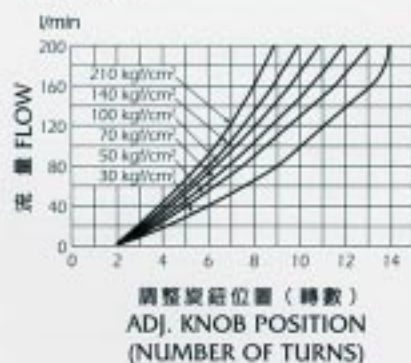

● TV-※10

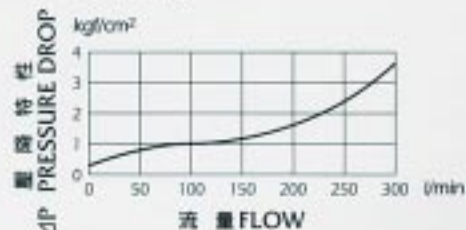

單向節流閥 Throttle And Check Valves



閥類型符號 SYMBOL
TCV-※



規格說明 SPECIFICATION :

型式 MODEL		最高使用壓力 MAX. OPERATING PRESSURE kgf/cm ²	流量 RATED FLOW l/min	重量 WEIGHT kg	
管式安裝 THREADED CONNECTIONS	板式安裝 SUB-PLATE MOUNTING				
TCV-T03-10	TCV-G03-10	250	30	1.5	2.3
TCV-T06-10	TCV-G06-10		80	3.8	4.3
TCV-T10-10	TCV-G10-10		200	7.3	8.6

型號說明 HOW TO ORDER :

TCV G - 03 - 10

附屬品 ATTACHMENT :

型式 MODEL	安裝螺絲 SOC HOL CAP SCREW
TCV-G03-10	M8 X 60L.....4pcs
TCV-G06-10	M10 X 75L.....4pcs
TCV-G10-10	M12 X 100L...4pcs

設計編號 DESIGN NUMBER

閥規格 VALVE SIZE
03 : 3/8" 06 : 3/4" 10 : 1 - 1/4"

安裝型式 MOUNTING
G : 板式安裝 SUB-PLATE MOUNTING
T : 管式安裝 THREADED CONNECTIONS

系列編號 SERIES NUMBER

Throttle And Check Valves

單位UNIT : mm

安裝尺寸 INSTALLATION DIMENSIONS

TCV - T※

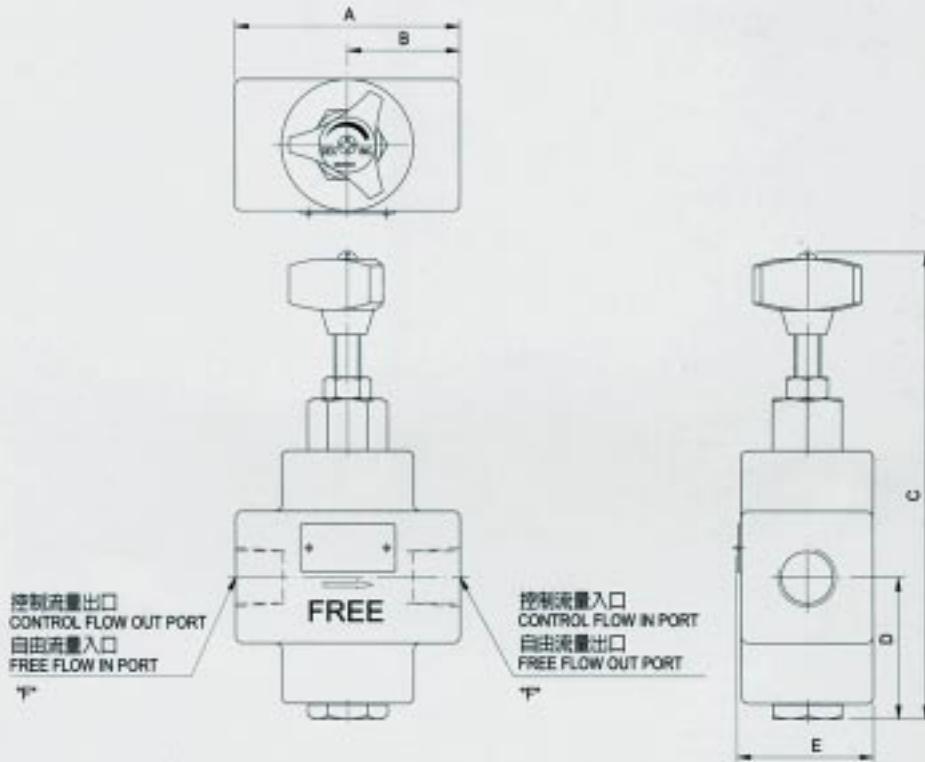

型式 MODEL	A	B	C	D	E	F
TCV-T03	68	34	180	60	41	PT 3 / 8"
TCV-T06	104	52	216	65.5	61	PT 3 / 4"
TCV-T10	130	65	228	77	82	PT 1 - 1 / 4"

Throttle And Check Valves

單位UNIT : mm

安裝尺寸 INSTALLATION DIMENSIONS

TCV - G※

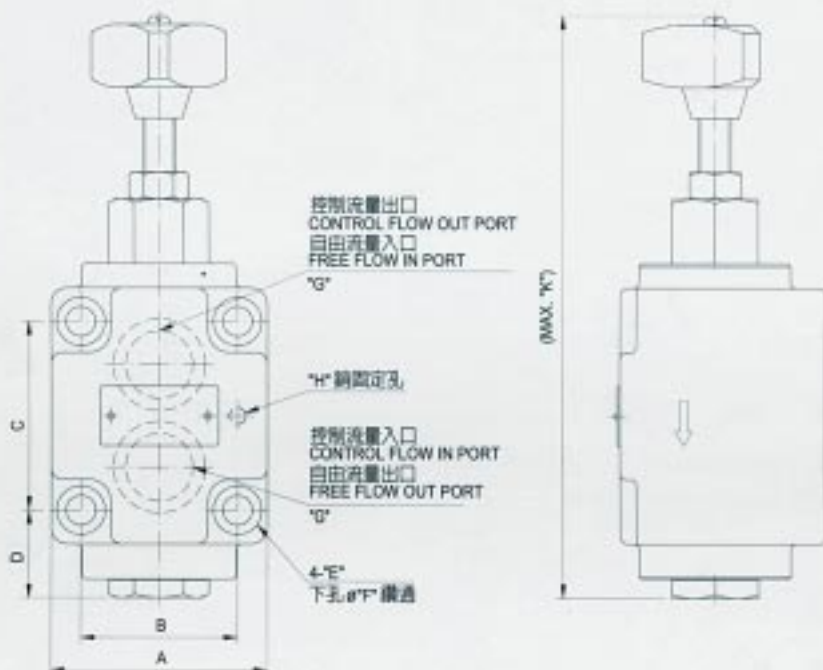

型式 MODEL	A	B	C	D	E	F	G	H	I	J	K
TCV-G03	61	40	60	30	∅14	∅9	∅14	∅6	63	35	180
TCV-G06	80	58	70	33	∅18	∅11	∅25	∅6	79	41	216
TCV-G10	100	72	92	31	∅20	∅14	∅30	∅6	97	50	228