

**基本規格 SPECIFICATIONS**

MPR-03 Series		
最大工作壓力 Maximum Pressure	bar	210 (3000 PSI)
最大壓力設定範圍 Max. Pressure Setting	bar	35, 70, 140, 210 (500, 1000, 2000, 3000 PSI)
最大流量 Rated Flow	LPM	70 (18.50 GPM)
重量 Weight 型式 Code P, A, B	Kgs	3.4 (7.5 Lbs)
液壓油品 Fluid Type		礦物性、耐磨性 Mineral, Anti-Wear
黏度範圍 Viscosity		10 ~ 400 (59 ~ 1854 SSU)
使用溫度 Operating Temperature	cSt	-15 ~ 70 (-5 ~ 158°F)
清潔度 Contamination Level	°C	$\beta_{10} \geq 75$ , NAS 12 級以內 Under NAS Class 12, 25 $\mu$
表面處理 Surface Treatment		磷酸鹽皮膜處理 Zinc Phosphate Compound

**型號說明 HOW TO ORDER**

**MPR - 03 P - 1 - 30 - K - A**

- ① ② ③ ④ ⑤ ⑥ ⑦

**① 閥系列 VALVE SERIES:**

MPR= 疊加式減壓閥  
Modular Pressure Reducing Valve

**② 通稱口徑**

**SUBPLATE MOUNTING SIZE:**

03= 通稱 Nominal 3/8" (9 mm)  
ISO CETOP5  
DIN NG 10  
NFPA D05

**③ 控制迴路 CONTROL PORT(S)**

A= A Port Only

Relief A to T

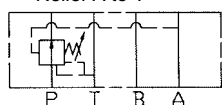

B= B 迴路控制

B Port Only

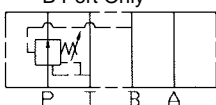

P= P 迴路控制

P Port Only

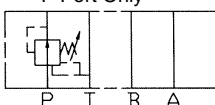

**④ 壓力調整範圍**

**ADJUSTMENT PRESSURE**

0=2 to 35 bar (30 to 500 PSI)  
1=8 to 70 bar (115 to 1000 PSI)  
2=35 to 140 bar (500 to 2000 PSI)  
3=70 to 210 bar (1000 to 3000 PSI)

**⑤ 設計型號 DESIGN NO.**

**⑥ 調整桿型式 ADJUSTMENT**

省略= 標準; 內六角調整  
Omit= Standard; Hex. Screw with Nut  
K= 旋鈕調整 Knob

**⑦ 調整桿方向 ORIENTATION**

省略= 標準; 調整桿在 B 側  
Omit= Standard; B Orientation  
A= 調整桿在 A 側  
A Orientation

**特性曲線 PERFORMANCE**

測試條件 Test Conditions

溫度 Oil Temperature: 50°C (122°F)

黏度 Viscosity: 35 cSt (163 SSU)

**壓力降特性曲線 Pressure Drop**

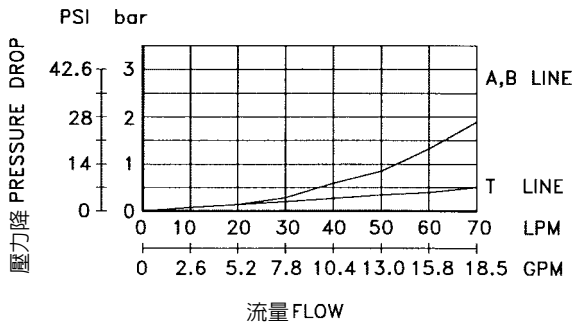

**壓力降特性曲線 (滑柱全開) Pressure Drop (Spool Fully Open)**

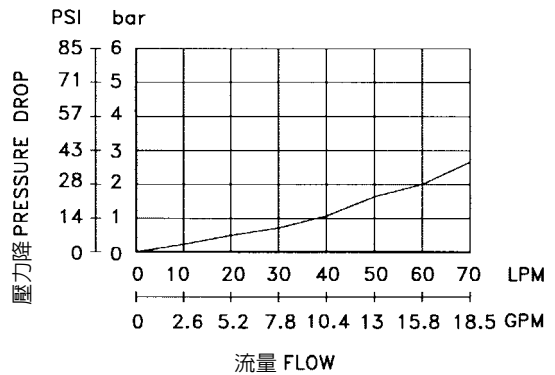

**先導流量特性 Drain Characteristic**

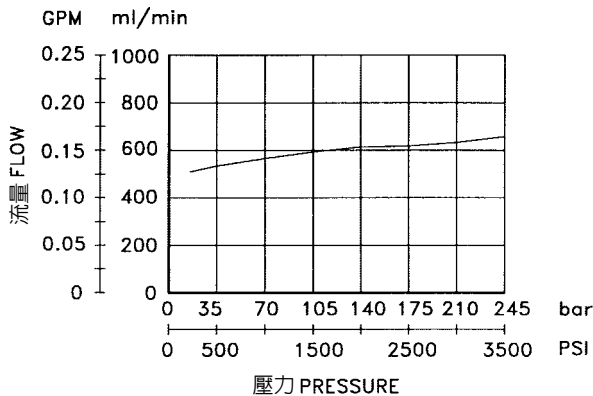

**壓力設定：**

調整螺絲或把手順時針方向調整為壓力增加，逆時針方向調整為壓力減弱，壓力調整後請鎖緊六角螺帽或塑膠安裝螺帽。

**Pressure Setting**

Facing to adjustment screw or knob, clockwise increasing pressure, counterclockwise decreasing pressure.

Please tighten hex. nut or plastic setting nut after pressure adjusted.

單位 Unit:mm[inch]

### 外型尺寸 DIMENSIONS

#### MPR-03P/A/B(A)

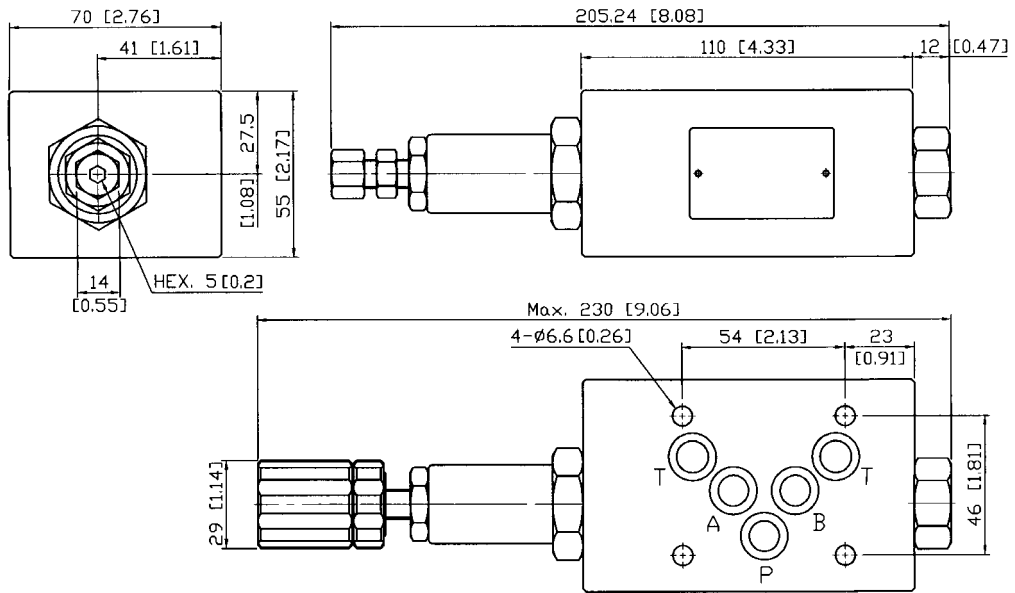

#### MPR-03P/A/B(B)

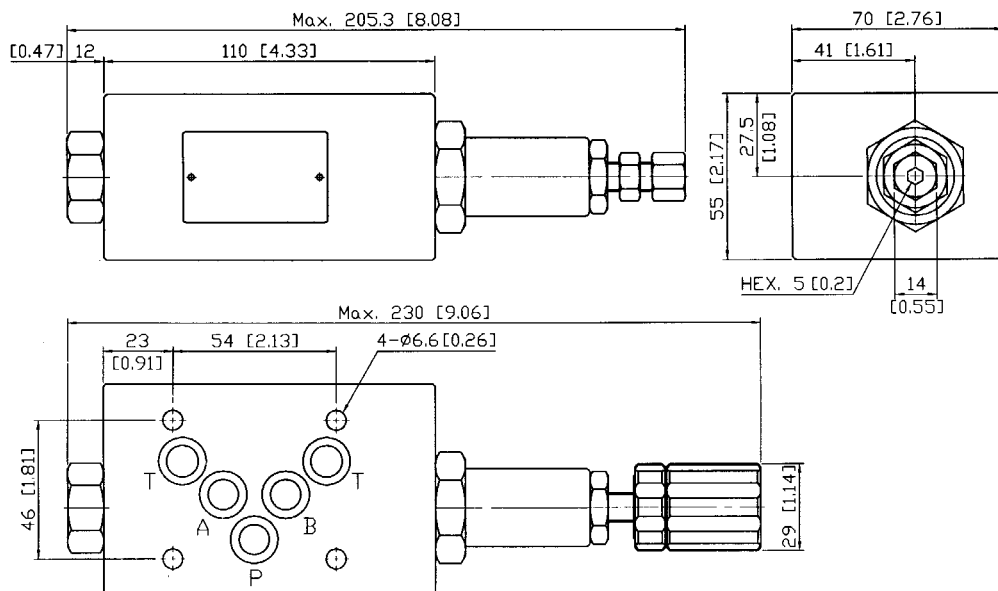

**按裝面 Mounting Interface :**

ISO 4401-AC-05-4-A

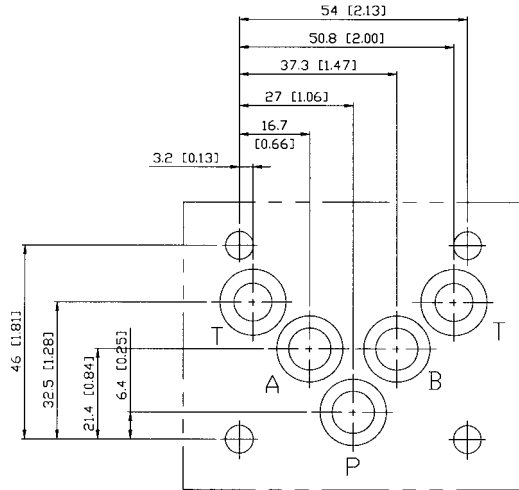

**密封件 SEAL KITS**

**MPR-03P**

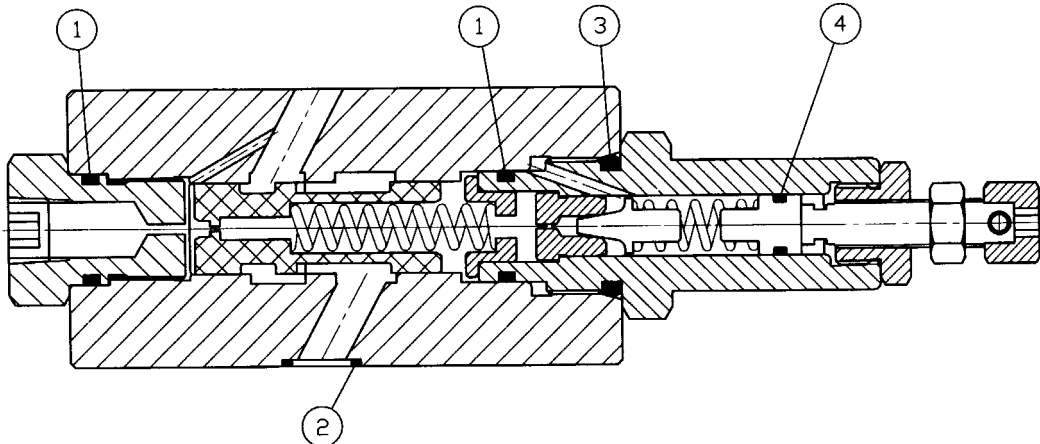

No.	種類 Description	數量 Q'ty	型號 Specification
1	O 型環 O-ring	2	P18 HS70
2	O 型環 O-ring	5	AS568-014 HS90
3	O 型環 O-ring	1	P22A HS70
4	O 型環 O-ring	1	P9 HS70