

Up to 25 MPa (3630 PSI), 10 L/min (2.6 U.S.GPM)

These modular valves have the same mounting surface as those for the DSG-005 solenoid operated directional valves and a uniform thickness. Several of them can be stacked and bolted together into a hydraulic circuit. Because of this compactest design, the valves fit in a narrow space, so they are optimal for machine tools, work vehicles and labor-saving machines.



■ Modular Valve Type

Class	Model Numbers	Graphic Symbols	Page
	Solenoid Operated Directional Valves DSG-005-***-10/30/90		Refer to the Catalogue No. Pub.EC-0401.
Flow Control Valves	Throttle and Check Valves (for "A&B-Lines", Metre-out) MSW-005-X-10/1090		4
	Throttle and Check Valves (for "A&B-Lines", Metre-in) MSW-005-Y-10/1090		4
Directional Control Valves	Pilot Operated Check Valves (for "B-Line") MPB-005-2-10/1090		6
	Pilot Operated Check Valves (for "A&B-Lines") MPV-005-2-10/1090		6
Base Plates and Mounting Bolts	Base Plates MMC-005-* -10/1080/1090		8
	Bolt Kits MBK-005-* -10/1090		11

■ Example of Stacking Configuration

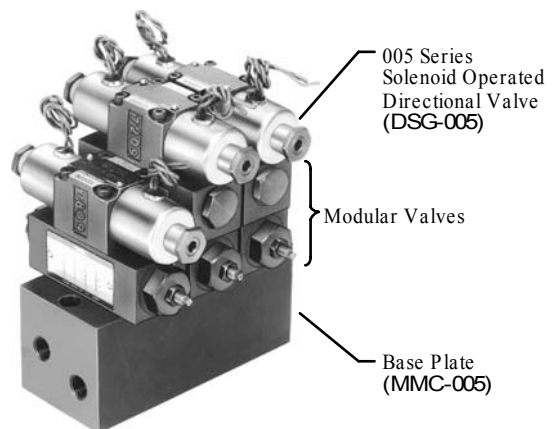
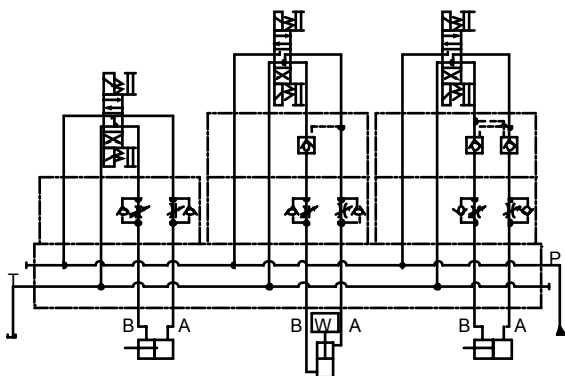

■ Instructions

● Caution in the selection of valves and circuit designing

The selection of modular valves, to suit a particular function or hydraulic circuit, are made in exactly the same way as conventional valves taking into account of the flow and pressure of each valve to be used. In some cases, the stacking system may be restricted, so please refer to the following instructions for stacking sequence. Please note, that when designing a system using modular stacking valves, due consideration should be given to working space for future maintenance.

● Stacking sequence when using pilot operated check valves and throttle and check valves (metre-out).

In A to T flow in the drawing left (incorrect), pressure is generated at  part with a throttle effect of the throttle and check valve.

The pressure so generated acts to shut the pilot operated check valve and eventually creates an open and shut operation of the valve repeatedly which may cause the cylinder to have a knocking effect (the same effect will occur in the case of B to T flow). Therefore, the stacking sequence in the drawing right (correct) is required in this combination.

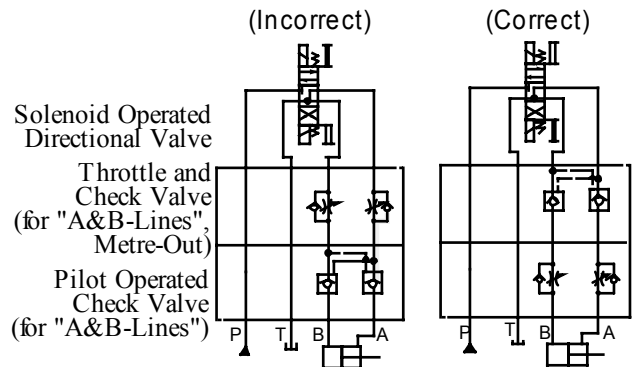

■ Assembly

Assembly should be carried out in clean environment conditions and in accordance with the following procedure. Cautious attention should be paid to ensure that the valves and their mounting surface are clean and free from dirt or other foreign materials.

● Assembly Procedure:

- (1) Referring to the circuit diagram, stack up the modular valves and solenoid operated directional valve, while setting their O-ring sides facing toward the mounting side and ensuring the correspondence between locating pin and pin slot.
- (2) Make both valve sides straight.
- (3) Take 4 bolts from the mounting bolt kit and tighten them in the specified torque.

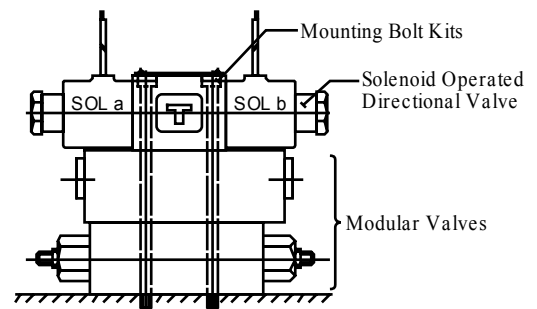

⚠ CAUTION

- Keep all installation holes and clean. Failure to do this may cause fire due to oil leakage.
- Before installing the product, be sure all specified bolts are tightened to the specified torque levels. Tightening to levels outside specifications may cause improper operation, damage, oil leakage, etc.

■ Specifications

Maximum Operating Pressure.....25 MPa (3630 PSI)
 Maximum Flow Rate ..10 L/min (2.6 U.S. GPM)
 Number of Stack1.- 3 stacks*
 ★ Solenoid operated directional valve is included in the number of stack.

005 Series Solenoid Operated Directional Valves

YUKEN 005 SERIES MODULAR VALVES are designed for use with solenoid operated directional valve having an interface such as yuken's DSG-005. Please refer to the Catalogue No. Pub. EC-0401 for details.

■ Hydraulic Fluids

● Fluid Types

Any type of hydraulic fluid listed in the table below can be used.

Petroleum base oils	Use fluids equivalent to ISO VG 32 or VG 46.
Synthetic fluids	Use phosphate ester or polyol ester fluid. When phosphate ester fluid is used, prefix "F-" to the model number because the special seals (fluororubber) are required to be used.
Water containing fluids	Use water-glycol fluid.

Note: For use with hydraulic fluids other than those listed above, please consult your Yuken representatives in advance.

● Recommended Viscosity and Temperatures

Always be sure to use hydraulic fluids within the stipulated conditions shown below:
 Viscosity: 15 to 200 mm²/s (77 to 900 SSU), Temperature: -15 to +60°C (5 to 140°F)

● Control of Contamination

Due caution must be paid to maintaining control over contamination of the hydraulic fluids which may otherwise lead to breakdowns and shorten the life of the valve. Please maintain the degree of contamination within NAS 1638-Grade 11. Use 20 μm or finer line filter.

■ Base Plates and Sub-Plates

When mounting the modular valves, use base plates and sub-plates specified below. If these base plates and the sub-plates are not used, ensure that the mounting surface has a good machined finish.

Base Plates		Sub-Plates	
Model Numbers	Page	Model Numbers	Page
MMC-005-* -10/1080/1090	8	DSGM-005* -10/1080/1090	★

★ For the details of Sub-Plate, see the following DSG-005 Catalogue: Catalogue No. Pub-EC-0401.

■ Mounting Bolts

005 series modular valves are mounted using four socket head cap screws which are supplied in a kit form. When mounting, see the following table for tightening torque. After the test run, be sure to tighten again firmly with the specified torque.

Bolt Kit Model Numbers	Tightening torque Nm (in. lbs.)
MBK-005-* -10 MBK-005-* -1090	2.5 - 3.5 (22 - 30)

■ Pressure Drop

Pressure drop curves of the modular valves are those based on viscosity of 30 mm²/s (141 SSU) and specific gravity of 0.850. When using the modular valves in conditions other than the above mentioned, find the appropriate values referring to the following table and formula.

- For any other viscosity, multiply the factors in the table below.

Viscosity	mm ² /s	15	20	30	40	50	60	70	80	90	100
	SSU	77	98	141	186	232	278	324	371	417	464
Factor		0.84	0.91	1.00	1.07	1.14	1.19	1.24	1.28	1.32	1.35

- For any other specific gravity (G'), the pressure drop (ΔP') may be obtained from the following formula.

$$\Delta P' = \Delta P (G'/0.850)$$

Specifications

Model Number	Max. Operating Pressure MPa (PSI)	Max. Flow L/min (U.S.GPM)
MSW-005-* -10/1090	25 (3630)	10 (2.6)

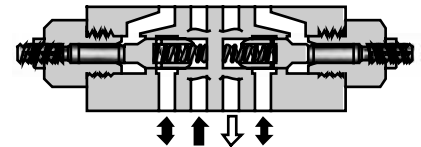

Model Number Designation

MSW	-005	-X	-10	*
Series Number	Valve Size	Direction of Flow	Design Number	Design Standard
MSW : Throttle and Check Valve for A&B-Lines	005	X : Metre-out Y : Metre-in	10	Refer to ★

★ Design Standards : None Japanese Standard "JIS" and
European Design Standard
90 N. American Design Standard

Flow Adjustment

To make flow rate adjustment, loosen the lock nut and turn the flow adjustment screw clockwise or anti-clockwise. To throttle the flow, turn the screw clockwise. Be sure to retighten the lock nut firmly after the adjustment of the flow rate is completed.

Graphic Symbols

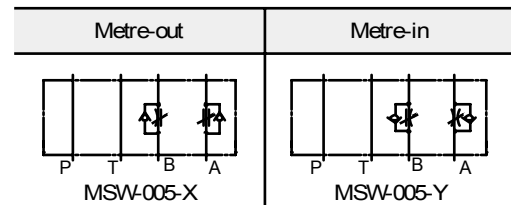

Typical Performance Characteristics

Hydraulic Fluid : Viscosity 30 mm²/s (141 SSU), Specific Gravity 0.850

Pressure Drop for P&T-Lines

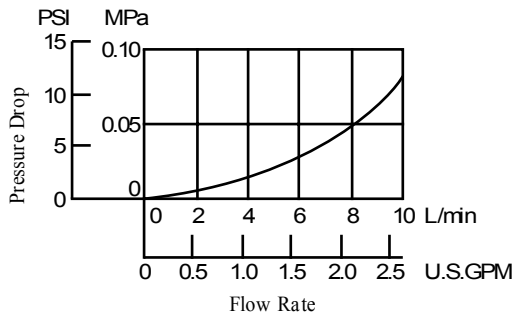

Pressure Drop for Free Flow

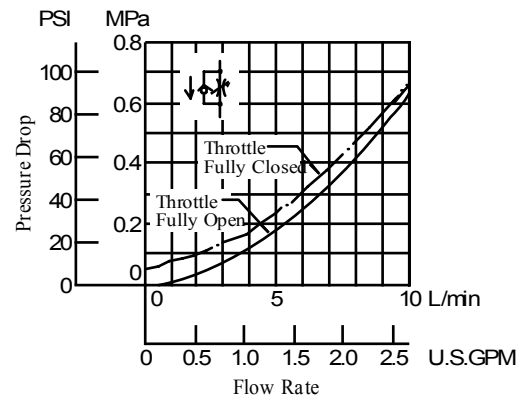

Metred Flow vs. Screw Position

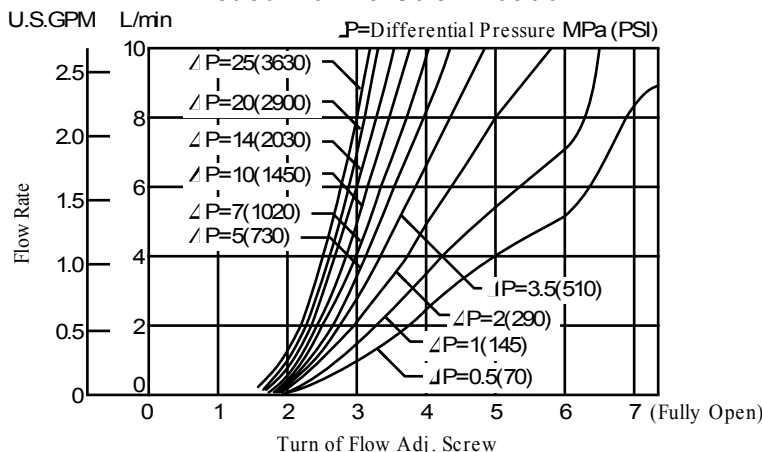

Pressure Drop at Throttle Fully Open

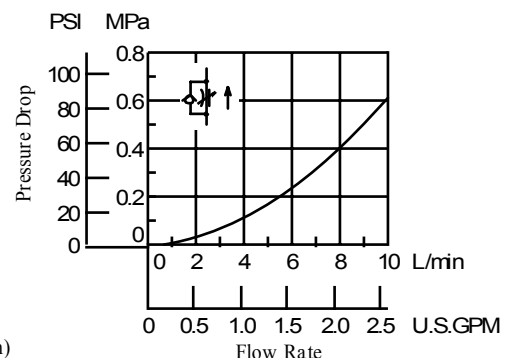

MSW-005- $\begin{matrix} X \\ Y \end{matrix}$ -10/1090

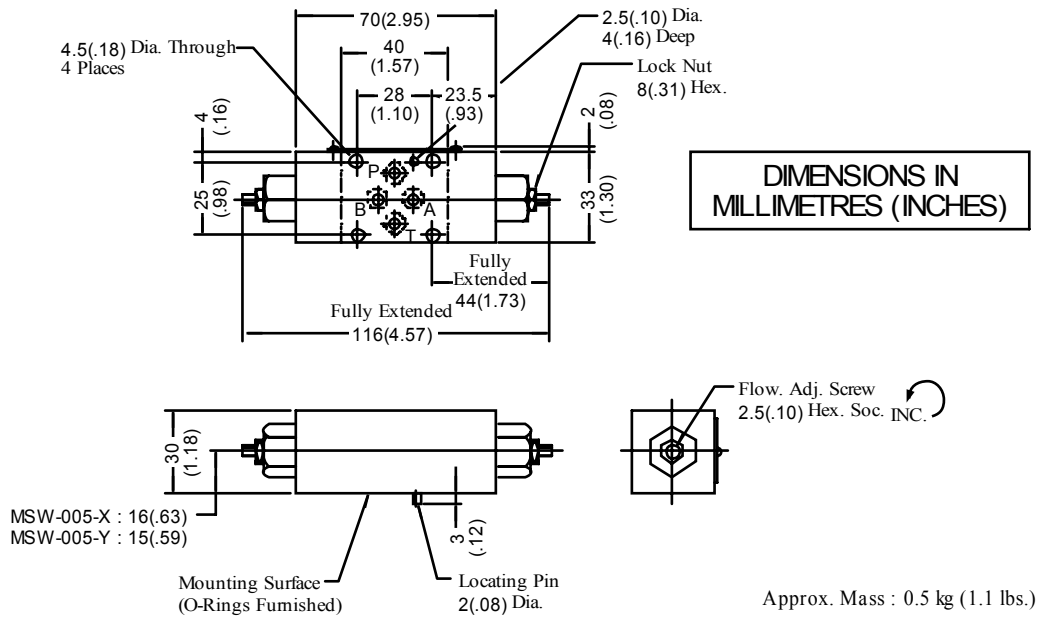

■ Spare Parts List

MSW-005- $\begin{matrix} X \\ Y \end{matrix}$ -10/1090

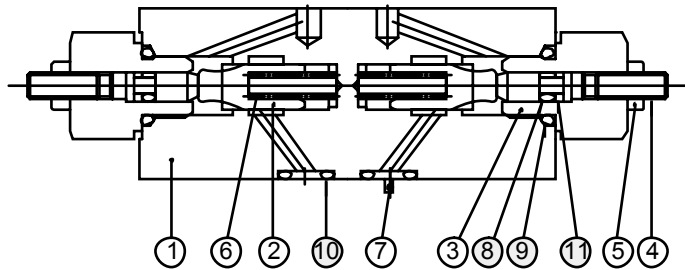

● List of Seals

Item	Name of Parts	Part Numbers	Qty .	Remarks
8	O-Ring	SO-NA-P3	2	Included in Seal Kit Kit No. : KS-MSW-005-10
9	O-Ring	SO-NB-P10	2	
10	O-Ring	SO-NB-P5	4	
11	Back Up Ring	SO-BB-P3	2	

Note : When ordering seals, please specify the seal kit number from the table above.

⚠ CAUTION

When making replacement of seals, please do it carefully after reading through the relevant instructions in the Operator's Manual.

■ Specifications

Model Number	Max. Operating Pressure MPa (PSI)	Max. Flow L/min (U.S.GPM)
MPB-005-2-10/1090 MPW-005-2-10/1090	25 (3630)	10 (2.6)



■ Model Number Designation

MPW	-005	-2	-10	*
Series Number	Valve Size	Cracking Pressure MPa (PSI)	Design Number	Design Standard
MPB : Pilot Operated Check Valve for B-Line MPW : Pilot Operated Check Valve for A&B-Lines	005	2 : 0.2 (29)	10	Refer to ★

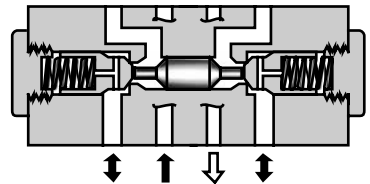

★ Design Standards : None Japanese Standard "JIS" and European Design Standard
90 N. American Design Standard

Graphic Symbols

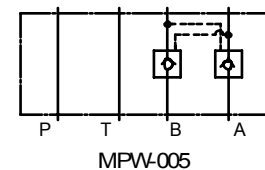
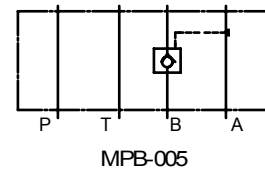

■ Typical Performance Characteristics

Hydraulic Fluid : Viscosity 30 mm²/s (141 SSU), Specific Gravity 0.850

Pressure Drop for Free Flow / Reversed Controlled Flow

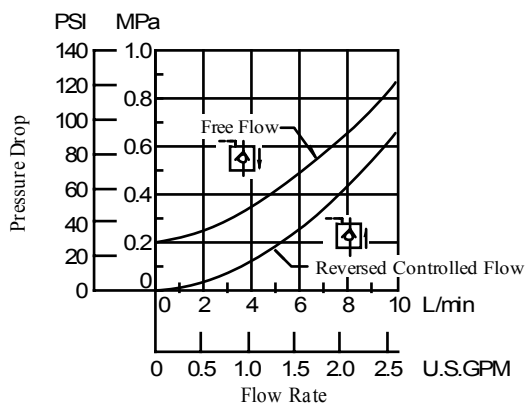

Pressure Drop

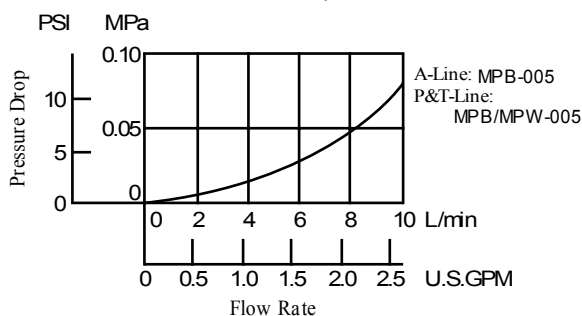

Min. Pilot Pressure

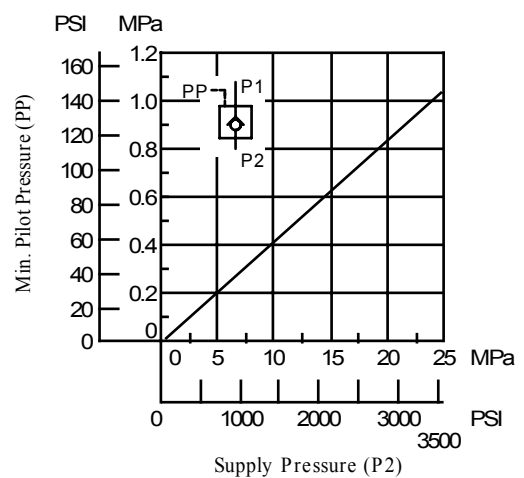

MPW-005-2-10/1090

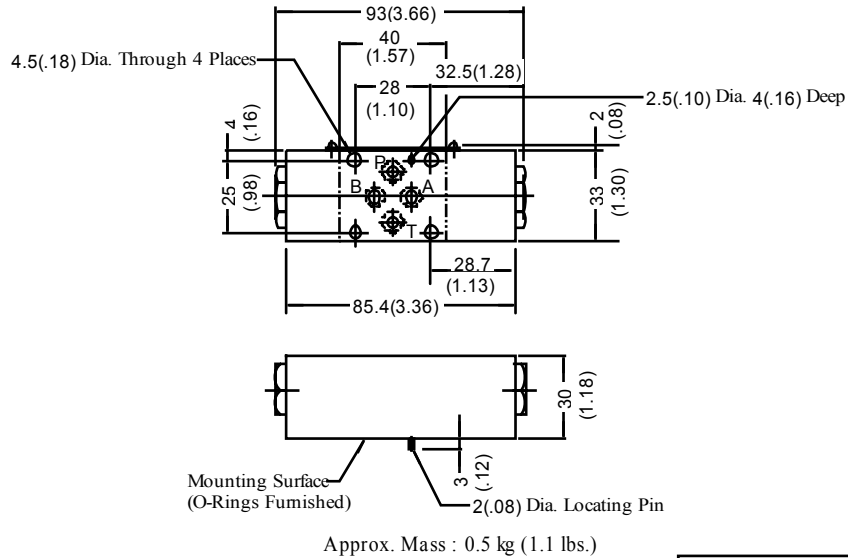

Approx. Mass : 0.5 kg (1.1 lbs.)

DIMENSIONS IN MILLIMETRES (INCHES)

MPB-005-2-10/1090

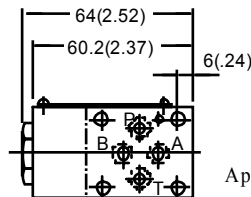

Approx. Mass : 0.4 kg (0.9 lbs.)

● For other dimensions, refer to the "MPW-005".

■ Spare Parts List

MPW-005-2-10/1090

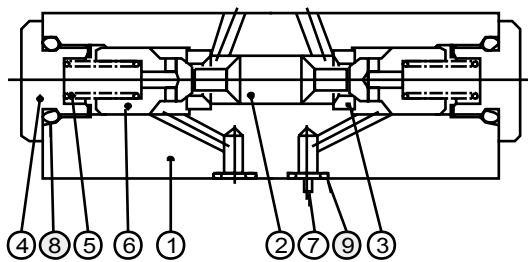

MPB-005-2-10/1090

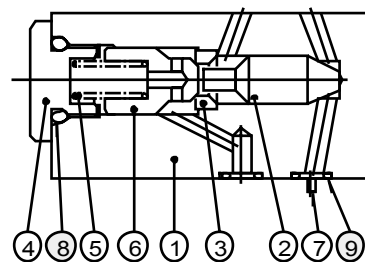

● List of Seals

Item	Name of Parts	Parts Numbers	Qty.	
			MPW	MPB
8	O-Ring	SO-NB-P12	2	1
9	O-Ring	SO-NB-P5	4	4

Note: When ordering seals, please specify the seal kit number from the table right.

● List of Seal Kits

Model Numbers	Seal Kit Numbers
MPB-005	KS-MPB-005-10
MPW-005	KS-MPW-005-10

⚠ CAUTION

When making replacement of seals, please do it carefully after reading through the relevant instructions in the Operator's Manual.

■ Specifications

Maximum Operating Pressure 25 MPa (3630 PSI)

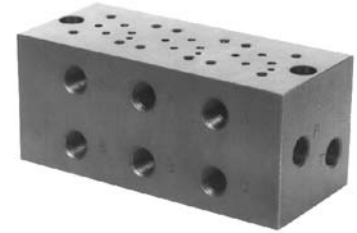

■ Model Number Designation

MMC	-005	-5	-10	*
Series Number	Plate Size	Number of Stations	Design Number	Design Standard
MMC : Base Plate	005	1 : 1 Station 2 : 2 Stations 3 : 3 Stations 4 : 4 Stations 5 : 5 Stations	10	None : Japanese Standard "JIS" 80 : European Design Standard 90 : N.American Design Standard

■ Instructions

- Port Used: Base plate has more than one pressure port "P" and tank port "T". Any one of these ports or two or more ports may be used. However, please note that the ports marked with (P) or (T) in the drawing are normally plugged. Remove the plugs when using such ports. Make sure that ports that are not currently used are properly plugged.

Graphic Symbols

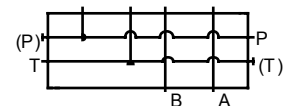

MMC-005-1

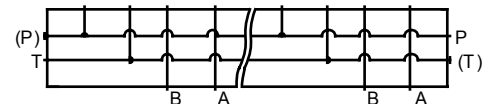

MMC-005-2-5

■ Mounting Surface Dimensions for 005 Series Modular Valve

When standard base plates (MMC-005) are not used, the mounting surface described on the right must be prepared. The mounting surface should have a good machined finish.

Design Std.	"C" Thd.	"E"
Japanese Std. "JIS" and European Design Std.	M4	8 (.31)
N. American Design Std.	No.8 - 32 UNC	10 (.39)

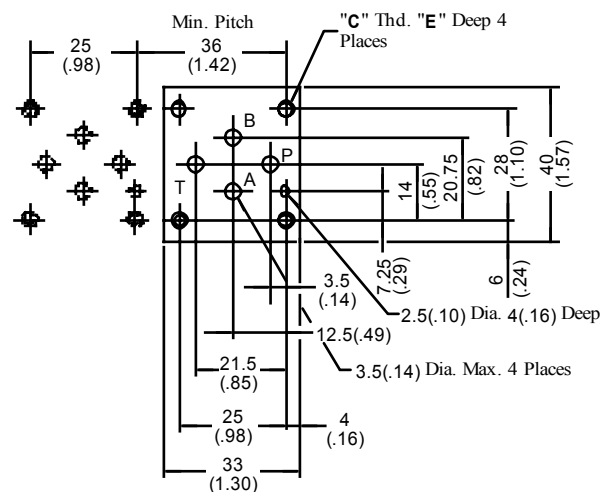

DIMENSIONS IN
MILLIMETRES (INCHES)

MMC-005-1-10/1090

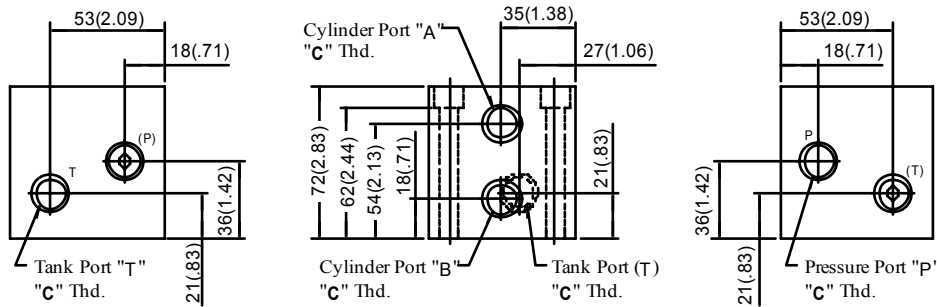
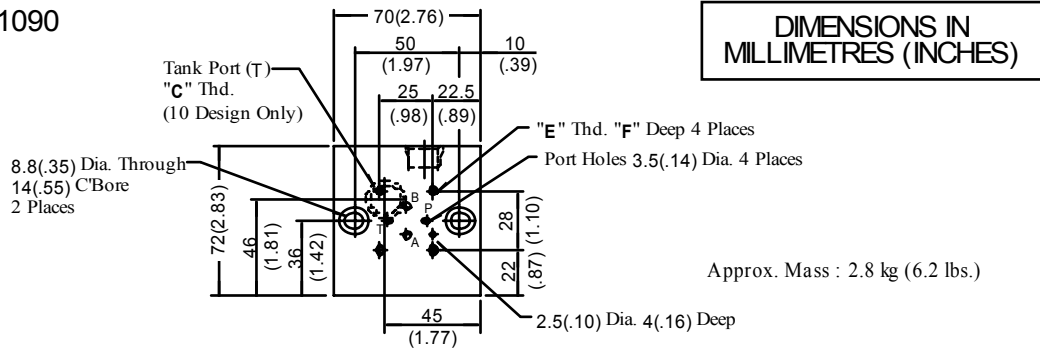

MMC-005-*/-10/1090

Number of Station
(2-5 Stations)

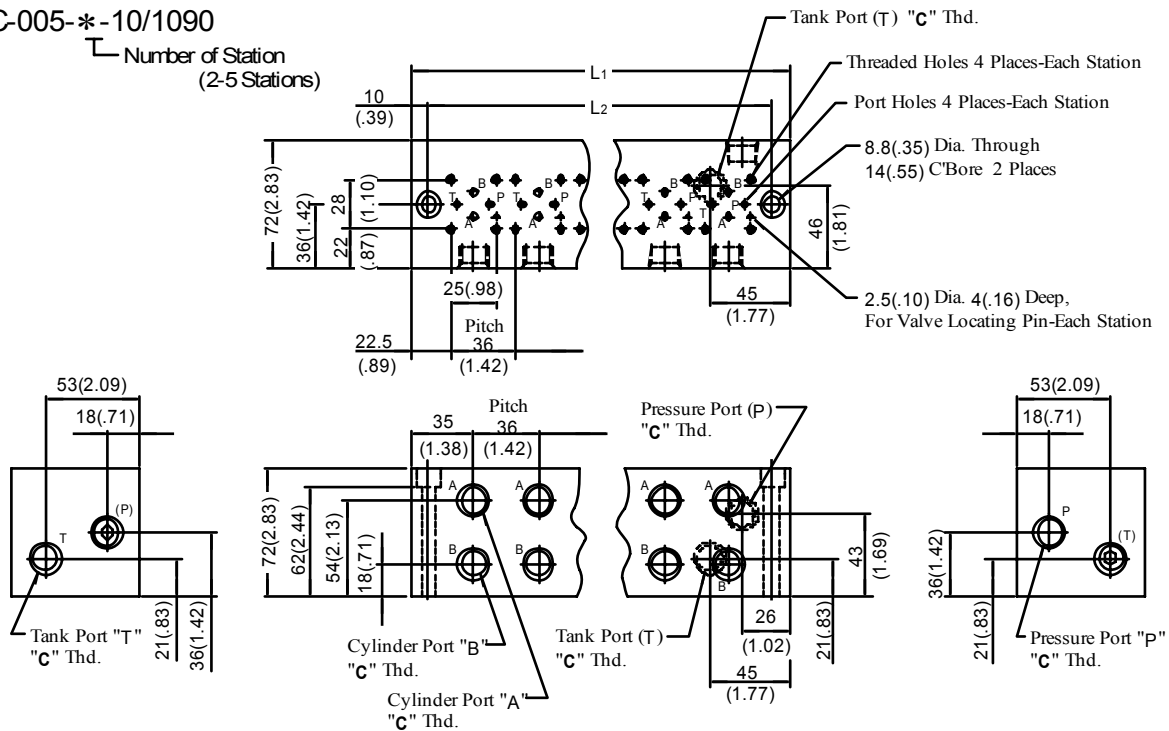

* For other dimensions, refer to the above Model MMC-005-1.

Model Numbers	Thread Size		Dimensions mm (Inches)
	"C" Thd.	"E" Thd.	
MMC-005-*/-10	Rc 3/8	M4	8 (.31)
MMC-005-*/-1090	3/8 NPT	No. 8-32 UNC	10 (.39)

Model Numbers	Dimensions mm (Inches)		Approx. Mass kg (lbs.)
	L1	L2	
MMC-005-2	106 (4.17)	86 (3.39)	4.3 (9.5)
MMC-005-3	142 (5.59)	122 (4.80)	5.8 (12.8)
MMC-005-4	178 (7.01)	158 (6.22)	7.2 (15.9)
MMC-005-5	214 (8.43)	194 (7.64)	8.7 (19.2)



MMC-005-1-1080

DIMENSIONS IN
MILLIMETRES (INCHES)

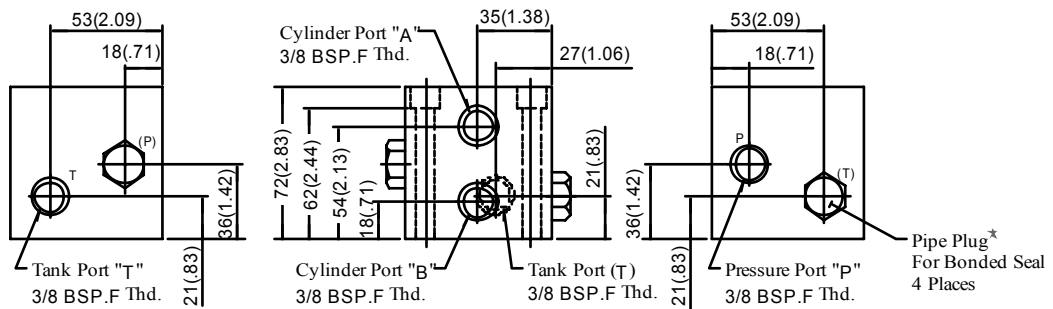
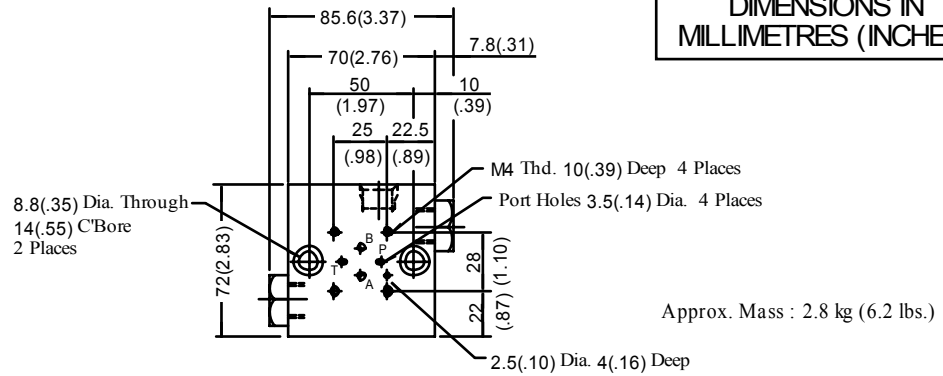

MMC-005-* -1080

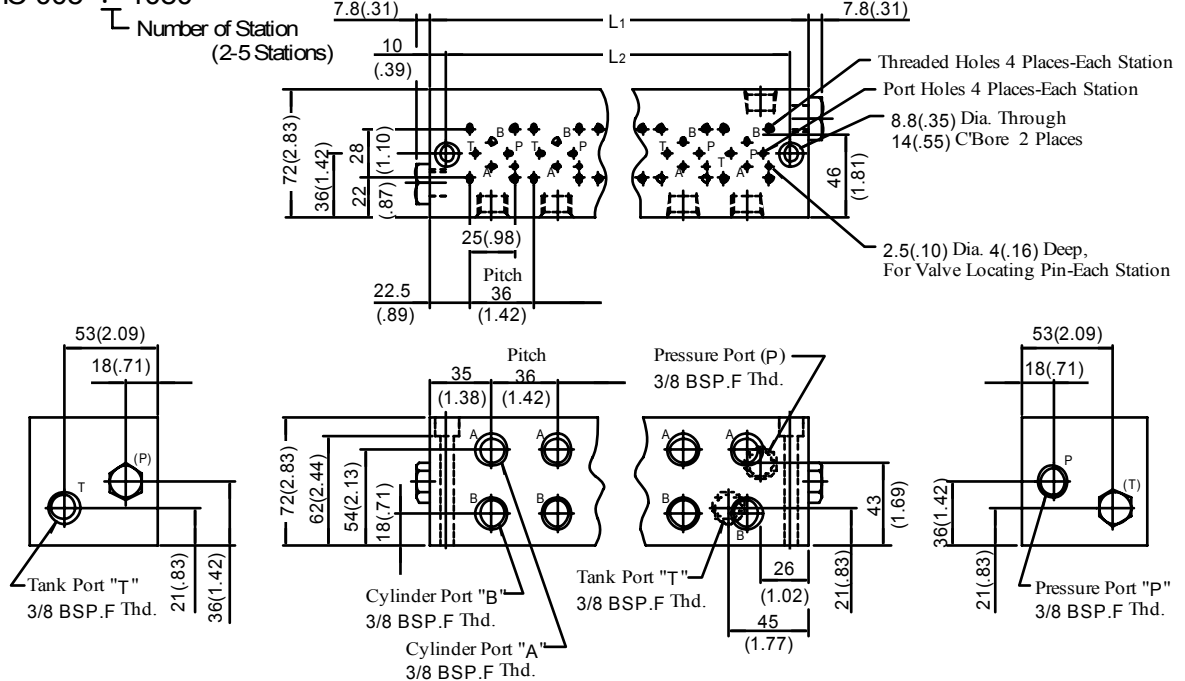

• For other dimensions, refer to the above Model MMC-005-1.

Model Numbers	Dimensions mm (Inches)		Approx. Mass kg (lbs.)
	L1	L2	
MMC-005-2	106 (4.17)	86 (3.39)	4.3 (9.5)
MMC-005-3	142 (5.59)	122 (4.80)	5.8 (12.8)
MMC-005-4	178 (7.01)	158 (6.22)	7.2 (15.9)
MMC-005-5	214 (8.43)	194 (7.64)	8.7 (19.2)

★ Detail of Pipe Plug

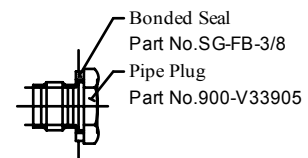

To mount the valves, four M4 bolts are used. The combination of valves varies with circuits. So, we have several mounting bolt kits suitable for different valve combinations. From the selection chart, choose a necessary bolt kit and specify it with model number when ordering.



Model Number Designation

MBK	-005	-02	-10	*
Series Number	Size of Modular Valve	Bolt Number	Design Number	Design Standard
MBK: Bolt Kits for Modular Valves	005	01,02,03 (Refer to the following chart)	10	None: Japanese Standard "JIS" and European Design Standard 90: N.American Design Standard

Bolt Kits Selection Chart

Model Numbers	Quantity of valves to be stacked		Approx. Mass g (lbs.)
	Solenoid Operated Directional Valve (DSG-005)	Modular Valve	
MBK-005-01-10*	1*	0	18(.04)
MBK-005-02-10*	1	1	30(.07)
MBK-005-03-10*	1	2	40(.09)

★ The solenoid operated directional valve comes with mounting bolts.

Bolts Kit Composition:

Soc. Hd. Cap Screw 4 Pcs.

Tightening Torque:

2.5 - 3.5 Nm (22-31 in. lbs.)

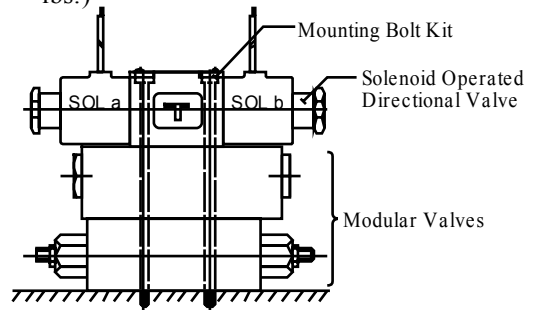

005 Series Modular Valves

MBK-005-* -10/1090

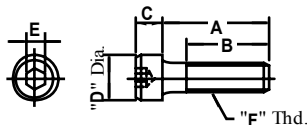

Model Numbers	Dimensions mm (Inches)					"F" Thd.
	A	B	C	D	E	
MBK-005-01-10	35 (1.38)	20 (.79)	4 (.16)	7 (.28)	3 (.12)	M4
MBK-005-02-10	65 (2.56)					
MBK-005-03-10	95 (3.74)					
MBK-005-01-1090	35 (1.38)	22.4 (.88)	4.17 (.164)	6.86 (.27)	3.62 (.143)	No. 8-32 UNC
MBK-005-02-1090	65 (2.56)					
MBK-005-03-1090	95.2 (3-3/4)					