

YUKEN

**SOLENOID OPERATED
DIRECTIONAL VALVES
DSG-005-***-30/3090
Sub-plate Mounting**

**DIRECTIONAL
CONTROLS**

Up to 25 MPa (3630 PSI), 10 L/min (2.6 U.S.GPM)

These DSG-005 series solenoid operated directional valves are the products newly developed as a "Mini-series". Compared with DSG-01 series, the valves are much more compactly manufactured but enjoy a maximum operating pressure of 25 MPa (3630 PSI) and a maximum flow rate of 10 L/min (2.6 U.S.GPM), while contributing further to a space saving requirement. Moreover, using wet armature solenoids, the valves ensure the long life.

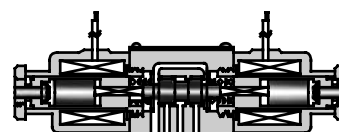

Specifications

Model Numbers	Max. Flow* L/min (U.S.GPM)	Max. Operating Pressure MPa (PSI)	Max. Tank-Line Back Pressure MPa (PSI)	Max. Changeover Frequency min ⁻¹ (Cycles/min)	Approx. Mass kg (lbs.)
DSG-005-3C*-30/3090	10 (2.6)	25 (3630)	7 (1020)	120	0.5 (1.1)
DSG-005-2B*-30/3090					0.4 (.9)

★ The maximum flow means the limited flow without inducing any abnormality to the operation (changeover) of the valve. The maximum flow differs according to the spool type and operating conditions. For details, please refer to the "List of Standard Models and Maximum Flow" on pages 3 and 4.

Solenoid Ratings

Electric Source	Coil Type	Frequency (Hz)	Voltage (V)		Current & Power at Rated Voltage		
			Source Rating	Serviceable	Inrush* (A)	Holding (A)	Power (W)
AC	A100	50	100	80 - 110	0.29	0.15	—
		60		90 - 120	0.26	0.11	
	A200	50	200	160 - 220	0.15	0.08	
		60		180 - 240	0.13	0.06	
DC	D12	—	12	10.8 - 13.2	—	1.2	15
	D24	—	24	21.6 - 26.4	—	0.6	

★ Inrush current in the above table shows rms values at maximum stroke.

Model Number Designation

F-	DSG	-005	-3	C	2	-D24	-30	*
Special Seals	Series Number	Valve Size	Number of Valve Position	Spool-Spring Arrangement	Spool Type	Coil Type	Design Number	Design Standard
F: Special seals for phosphate ester type fluids (Omit if not required)	DSG: Solenoid Operated Directional Valve	005	3	C: Spring Centred	2, 3, 40	AC A100, A200 DC D12, D24	30	Refer to *
			2	B: Spring Offset	2, 3			

★ Design Standards: None Japanese Standard "JIS" and European Design Standard
90 N. American Design Standard

■ Sub-plates

Piping Size	Japanese Standard "JIS"		European Design Standard		N. American Design Standard		Approx. Mass kg (lbs.)
	Sub-plate Model Numbers	Thread Size	Sub-plate Model Numbers	Thread Size	Sub-plate Model Numbers	Thread Size	
1/8	DSGM-005X-10	Rc 1/8	DSGM-005X-1080	1/8 BSP.F	DSGM-005X-1090	1/8 NPT	0.8 (1.8)
1/4	DSGM-005Y-10	Rc 1/4	DSGM-005Y-1080	1/4 BSP.F	DSGM-005Y-1090	1/4 NPT	0.8 (1.8)

- Sub-plates are available. Specify the sub-plate model number from the table above. When sub-plates are not used, the mounting surface should have a good machined finish.

■ Mounting Bolts

Four socket head cap screws in the table below are included.

Descriptions	Soc. Hd. Cap Screw (4 Pcs.)	Tightening Torque
Japanese Standard "JIS" European Design Standard	M4 × 35 Lg.	2.5 - 3.5 Nm (22.1 - 31.0 in.lbs.)
N. American Design Standard	No. 8-32 UNC × 1.38 Lg.	

■ Hydraulic Fluids

● Fluid Types

Any type of hydraulic fluid listed in the table below can be used.

Petroleum base oils	Use fluids equivalent to ISO VG 32 or VG46.
Synthetic fluids	Use phosphate ester or polyol ester fluid. When phosphate ester fluid is used, prefix "F-" to the model number because the special seals (fluororubber) are required to be used.
Water containing fluids	Use water-glycol fluids or W/O emulsion type fluids.

Note: For use with hydraulic fluids other than those listed above, please consult your Yuken representatives in advance.

● Recommended Viscosity and Oil Temperatures

Always be sure to use hydraulic fluids within the stipulated conditions shown below:
Viscosity: 20-200 mm²/s (100-930 SSU), Temperature: -15 to +60°C (5 to 140°F).

● Control of Contamination

Due caution must be paid to maintaining control over contamination of the hydraulic fluids which may otherwise lead to breakdowns and shorten the life of the valve. Please maintain the degree of contamination within NAS 1638-Grade 11. Use 20 μm or finer line filter.

■ Instructions

● Solenoids

As the solenoids have no surge absorbers, please pay cautious attention to a surge voltage.

● Mounting Posture

For any model, there are no restrictions regarding the mounting posture.

● Solenoid Energisation

When energising one solenoid, be sure to de-energise another solenoid beforehand.

● Tank Port

Do not connect the tank port to any pipe line having a surge pressure in it. Be sure to keep the end of the tank line pipe below the oil level. As the solenoids are of wet type structure, it is necessary to make piping in such condition that the inside of the valve is always filled with the fluid.

● Operating Force for Manual Override Push Pin

Please note that as the back pressure of the tank line rises, the manual override push pin turns hard to operate. (see the graph below).

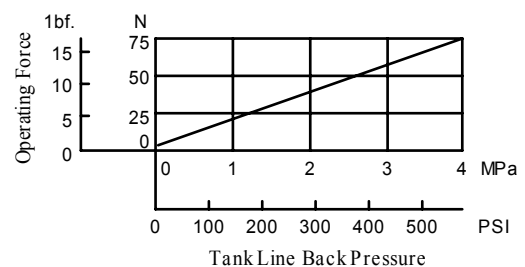

■ List of Standard Models and The Maximum Flow

● Models with AC Solenoids : DSG-005-***-A*-30/

Model Numbers	Graphic Symbols	Max. Flow L/min											
						P → A [Port "B" Blocked]				P → B [Port "A" Blocked]			
		Working Pressure MPa				Working Pressure MPa				Working Pressure MPa			
		5	10	16	25	5	10	16	25	5	10	16	25
DSG-005-3C2		10	10	10	10	10(10) 10(9)	10(2.5) 6(2)	4(1) 1.5(0.5)	1.5(0.5) 0.5(0.5)	10(10)	10(2.5)	4(1)	1.5(0.5)
DSG-005-3C3 [*]		8.5	8.5	8.5	8.5	10	10	10	10	10	10	10	10
DSG-005-3C40		10	10	10	2.5(2) 2(2)	10	10(2.5) 5(1)	4.5(1) 1(0.5)	0.5	10	10(2.5) 5(1)	4.5(1) 1(0.5)	0.5
DSG-005-2B2		10	10	10	10	2	2	2	2.5	10	10(2) 4.5(2)	2.5(1) 1(1)	1(0.5) 0.5(0.5)
DSG-005-2B3		10	10	10	10	4.5	4.5	4.5	4.5	10	10(9) 10(8.5)	10(4) 7(3.5)	6.5(1) 4(1)

Notes: 1. The relation between the maximum flow in the table above and the frequency/voltage (within the serviceable voltage) is as shown below.

(Example)

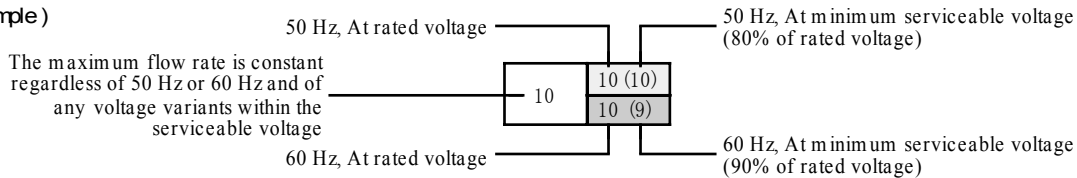

2. For the maximum flow rate in P → T of the valves with ^{*} mark, please see page 5.

● Models with DC Solenoids : DSG-005-***-D*-30/

Model Numbers	Graphic Symbols	Max. Flow L/min											
						P → A [Port "B" Blocked]				P → B [Port "A" Blocked]			
		Working Pressure MPa				Working Pressure MPa				Working Pressure MPa			
		5	10	16	25	5	10	16	25	5	10	16	25
DSG-005-3C2		10	10	10	10	10	4.5 3.5	3 2.5	2.5 2	10	4.5 3.5	3 2.5	2.5 2
DSG-005-3C3 [*]		8.5	8.5	8.5	8.5	10	10	10	10	10	10	10	10
DSG-005-3C40		10	10	7 3.5	3.5 3	10	5 3.5	3.5 3	3 2.5	10	5 3.5	3.5 3	3 2.5
DSG-005-2B2		10	10	10	10	2	2.5	2.5	3	10	5.5 3.5	4 3	3.5 3
DSG-005-2B3		10	10	10	10	4.5	4.5	4.5	4.5	10	10 7	8 6	8 6

Notes: 1. The relation between the maximum flow in the table above and the voltage (within the serviceable voltage) is as shown below.

(Example)

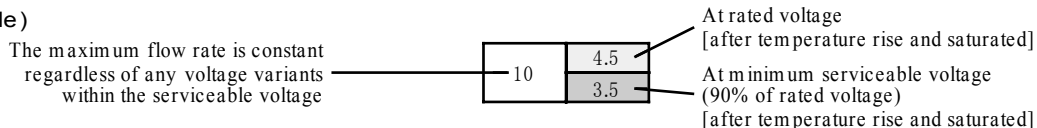

2. For the maximum flow rate in P → T of the valves with ^{*} mark, please see page 5.

List of Standard Models and The Maximum Flow

Models with AC Solenoids : DSG-005-***-A*-30/

Model Numbers	Graphic Symbols	Max. Flow U.S.GPM											
						P → A [Port "B" Blocked]				P → B [Port "A" Blocked]			
		Working Pressure PSI				Working Pressure PSI				Working Pressure PSI			
		730	1450	2320	3630	730	1450	2320	3630	730	1450	2320	3630
DSG-005-3C2		2.6	2.6	2.6	2.6	2.6(2.6)	2.6(.7)	1.1(.3)	.4(.1)	2.6(2.6)	2.6(.7)	1.1(.3)	.4(.1)
DSG-005-3C3*		2.2	2.2	2.2	2.2	2.6	2.6	2.6	2.6	2.6	2.6	2.6	2.6
DSG-005-3C40		2.6	2.6	2.6	.7(.5) .5(.5)	2.6	2.6(.7)	1.2(.3)	.1	2.6	2.6(.7)	1.2(.3)	.1
DSG-005-2B2		2.6	2.6	2.6	2.6	.5	.5	.5	.7	2.6	2.6(.5)	.7(.3)	.3(.1)
DSG-005-2B3		2.6	2.6	2.6	2.6	1.2	1.2	1.2	1.2	2.6	2.6(.5)	.7(.3)	.3(.1)

Notes: 1.The relation between the maximum flow in the table above and the frequency/voltage (within the serviceable voltage) is as shown below.

(Example)

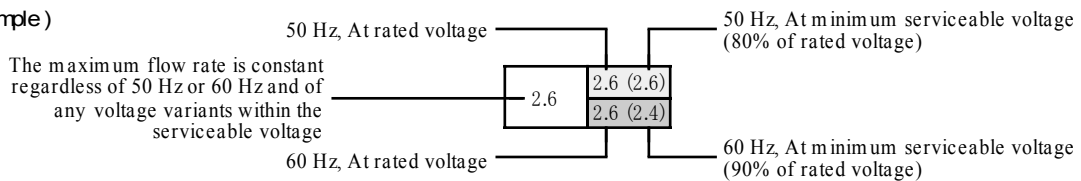

2.For the maximum flow rate in P→ T of the valves with * mark, please see page 5.

Models with DC Solenoids : DSG-005-***-D*-30/

Model Numbers	Graphic Symbols	Max. Flow U.S.GPM											
						P → A [Port "B" Blocked]				P → B [Port "A" Blocked]			
		Working Pressure PSI				Working Pressure PSI				Working Pressure PSI			
		730	1450	2320	3630	730	1450	2320	3630	730	1450	2320	3630
DSG-005-3C2		2.6	2.6	2.6	2.6	2.6	1.2	.8	.7	2.6	1.2	.8	.7
DSG-005-3C3*		2.2	2.2	2.2	2.2	2.6	2.6	2.6	2.6	2.6	2.6	2.6	2.6
DSG-005-3C40		2.6	2.6	1.8	.9	2.6	1.3	.9	.8	2.6	1.3	.9	.8
DSG-005-2B2		2.6	2.6	2.6	2.6	.5	.7	.7	.8	2.6	1.5	1.1	.9
DSG-005-2B3		2.6	2.6	2.6	2.6	1.2	1.2	1.2	1.2	2.6	2.6	2.6	2.1

Notes: 1.The relation between the maximum flow in the table above and the voltage (within the serviceable voltage) is as shown below.

(Example)

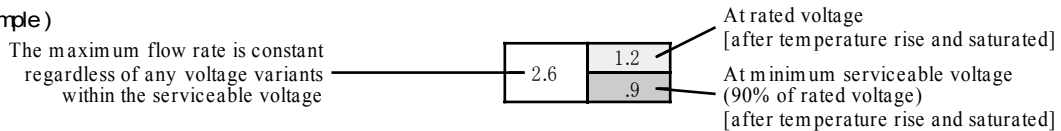

2.For the maximum flow rate in P→ T of the valves with * mark, please see page 5

Maximum Flow of Centre By-Pass

In valve type 3C3, in case where the actuator is put on in between the cylinder ports A and B as illustrated below and where the actuator moves and suspended at its stroke end and where the valve is then shifted to the neutral position in the suspended of the actuator, the maximum flow rates available are those as shown as the table below regardless of any voltage in the range of serviceable voltage.

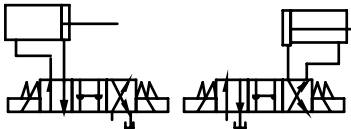

model Number	Max. Flow L/min(U.S.GPM)			
	5 MPa (730 PSI)	10 MPa (1450 PSI)	16 MPa (2320 PSI)	25 MPa (3630 PSI)
DSG-005-3C3	9.5 (2.5)	6 (1.6)	4.5 (1.2)	3 (.8)

Typical Changeover Time (Example)

Changeover time varies according to oil viscosity, spool type and hydraulic circuit.

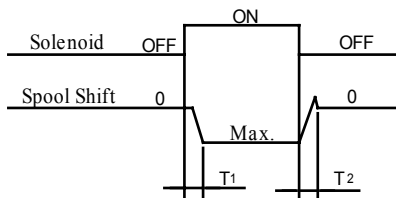

[Test Conditions]

Pressure: 16 MPa (2320 PSI)

Flow Rate: 5 L/min (1.3 U.S.GPM)

Viscosity: 30 mm²/s (141 SSU)

Voltage: Rated Voltage (After coil temperature rises and saturated)

Direction of Flow :

[Result of Measurement]

Model Numbers	Time ms	
	T1	T2
DSG-005-3C2-A*	14	60
DSG-005-3C2-D*	20	35
DSG-005-2B2-A*	14	23
DSG-005-2B2-D*	15	13

Pressure Drop

Pressure drop curves based on viscosity of 35 mm²/s (164 SSU) and specific gravity of 0.850.

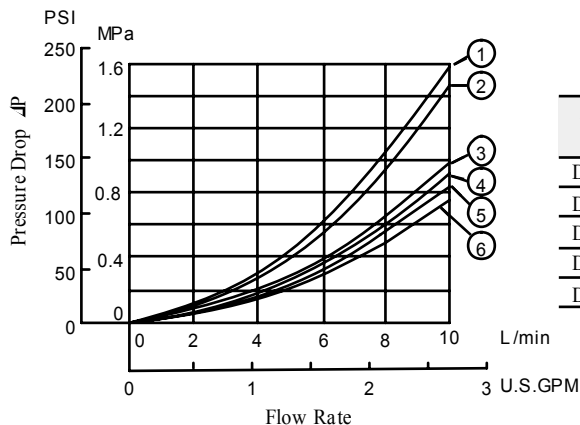

Model Numbers	Pressure Drop Curve Numbers				
	P → A	B → T	P → B	A → T	P → T
DSG-005-3C2	①	②	③	④	—
DSG-005-3C3	⑤	⑥	⑦	⑧	⑨
DSG-005-3C40	⑩	⑪	⑫	⑬	—
DSG-005-2B2	⑭	⑮	⑯	⑰	—
DSG-005-2B3	⑱	⑲	⑳	㉑	—

● For any other viscosity, multiply the factors in the table below.

Viscosity	mm ² /s	15	20	30	40	50	60	70	80	90	100
	SSU	77	98	141	186	232	278	324	371	417	464
Factor		0.81	0.87	0.96	1.03	1.09	1.14	1.19	1.23	1.27	1.30

● For any other specific gravity (G'), the pressure drop (P') may be obtained from the formula below.

$$P' = AP (G'/0.850)$$

Spring Centred : DSG-005-3C*-*-30/3090

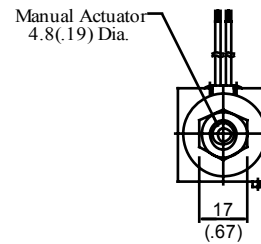
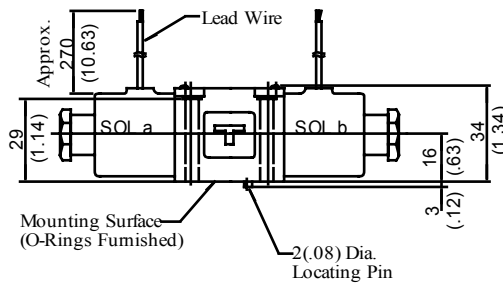
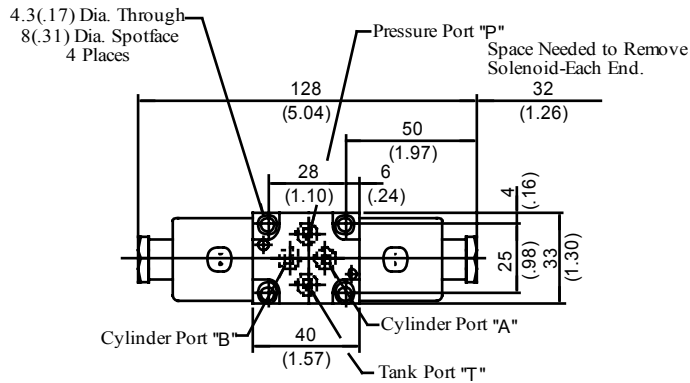

Spring Offset : DSG-005-2B*-*-30/3090

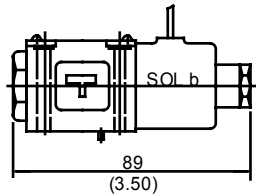

● For other dimensions, refer to "Spring Centred" type.

DIMENSIONS IN
MILLIMETRES (INCHES)

Sub-plate Model Numbers	Piping Size "C" Thd.	"D" Thd.
DSGM-005X-10	Re 1/8	M4
DSGM-005X-1080	1/8 BSP.F	
DSGM-005X-1090	1/8 NPT	
DSGM-005Y-10	Re 1/4	M4
DSGM-005Y-1080	1/4 BSP.F	
DSGM-005Y-1090	1/4 NPT	

Sub-plates : DSGM-005* -10/1080/1090

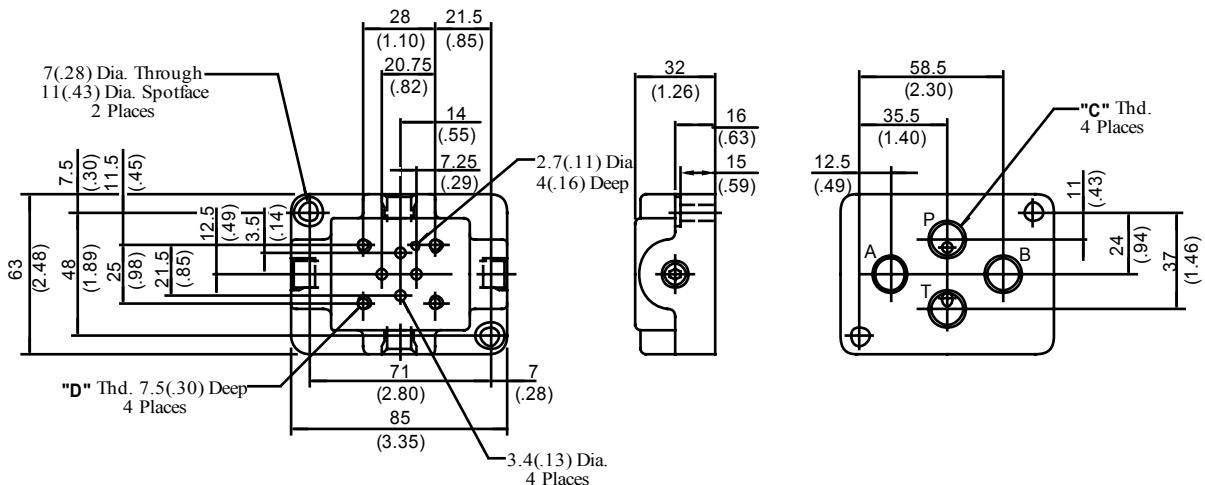

Spring Offset Type 2B*

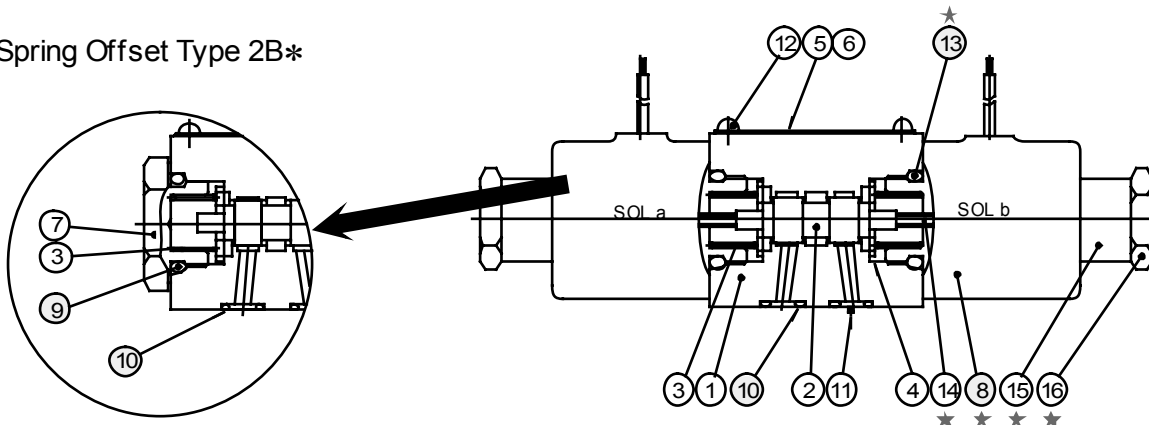

Solenoid assembly is composed of the parts marked with ★.

● List of Seals

Item	Name of Parts	Part Numbers	Qty.		Remarks
			3C*	2B*	
9	O-Ring	SO-NB-P18	—	1	
10	O-Ring	SO-NB-P5	4	4	
13	O-Ring	SO-NB-P14	2	1	Included in Solenoid Ass'y

Note: When ordering seals, please specify the seal kit number "KS-DSG-005-30".

● Solenoid Ass'y and Coil Ass'y No.

Valve Model Numbers	Solenoid Ass'y No.	⊗ Coil No.
DSG-005-***-A100-30/3090	SA05-100-30	C-SA05-100-30
DSG-005-***-A200-30/3090	SA05-200-30	C-SA05-200-30
DSG-005-***-D12-30/3090	SD05-12-30	C-SD05-12-30
DSG-005-***-D24-30/3090	SD05-24-30	C-SD05-24-30

⚠ CAUTION

When making replacement of seals or solenoid assemblies, please do it carefully after reading through the relevant instructions in the Operator's Manual.

⚠ WARNING

- Before maintenance or removal, do the following. Failure to do these may cause components to move, causing
- oil leakage or serious accidents.
 - Shut off the equipment's power supply, and be sure that all electric motors and engines have stopped.
 - Return pressure in all hydraulic systems to zero.